

vtech®

User's Manual

Go! Go! 
Smart Animals™
Playtime goes wild with learning!™

Tree House Hideaway Playset™



© 2014 VTech
Printed in China
91-002932-000®

Dear Parent,

Welcome to the world of **Go! Go! Smart Animals™**! We're excited you've decided to go on an adventure with us and explore all that **Go! Go! Smart Animals™** has to offer. These toys have been designed to give your child a thrilling learning experience with hours of fun.

Go! Go! Smart Animals™ features a collection of animals that interact with your child by lighting up and playing music and sounds while teaching your child letters and animal names*. But that's only the beginning of the learning excitement! When your child interacts with our innovative **SmartPoint™** technology, they will love hearing the animals respond to each **SmartPoint™** location on **Go! Go! Smart Animals™** and **Go! Go! Smart Wheels®** playsets* with different phrases, cheerful melodies, sing-along songs or sound effects.

Additionally, our **Go! Go! Smart Animals™** playsets include tracks that can be arranged in endless ways and can be connected to other playsets including **Go! Go! Smart Wheels®** to stimulate your child's creativity. The playsets also feature buttons, gears and other manipulative elements to encourage the development of your child's fine motor skills.

With **Go! Go! Smart Animals™**, playtime goes wild with learning!

Sincerely,

Your friends at **VTech®**

To learn more about **VTech®** toys, visit www.vtechkids.com

*Each sold separately.

INTRODUCTION

Thank you for purchasing the **VTech® Go! Go! Smart Animals™ Tree House Hideaway Playset™** learning toy!

Explore the **Go! Go! Smart Animals™ Tree House Playset™** by **VTech®**. Learn about animals, colors and more with the SmartPoint™ panda. Ride the elevator to the top of the tree house, then take a ride down the slide! For added fun, you can connect this playset to other Go! Go! Smart Animals™ and Go! Go! Smart Wheels® playsets (each sold separately).

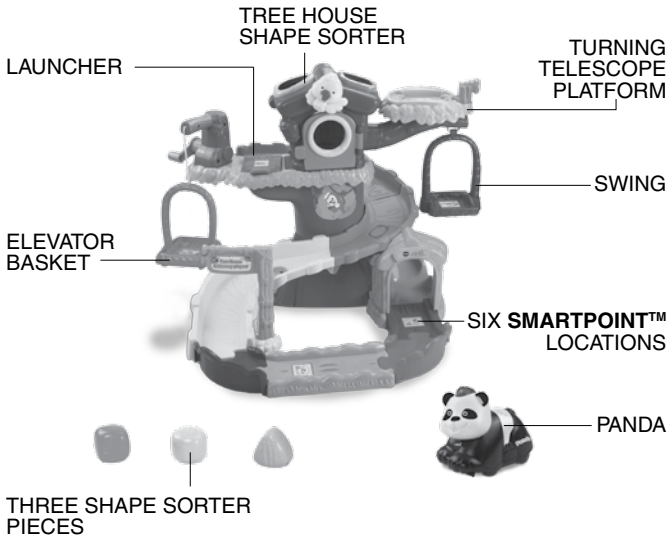

INCLUDED IN THIS PACKAGE



One tree house shape sorter



One treetop platform



One elevator basket bracket with hand crank



One **SmartPoint™** launcher



One welcome sign



One **SmartPoint™** elevator basket



One 90 - degree track, female



One 90 - degree track, male



One **SmartPoint™** straight track



One tree base



One entrance piece



One **SmartPoint™** entrance track



One shape sorter container



One turning **SmartPoint™** telescope platform



One tree trunk with track



One **SmartPoint™** swing



One swing bracket

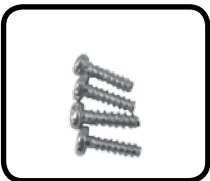

Four screws

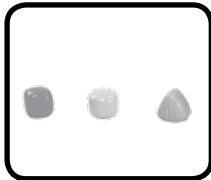

Three shape sorter pieces



Two spiral ramp pieces



One **VTech® Go! Go! Smart Animals™** panda

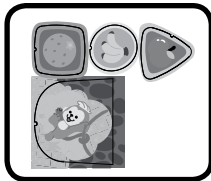

One sheet of labels

WARNING: All packing materials, such as tape, plastic sheets, wire ties and tags are not part of this toy, and should be discarded for your child's safety.

ATTENTION : Pour la sécurité de votre enfant, débarrassez-vous de tous les produits d'emballage tels que rubans adhésifs, feuilles de plastique, attaches et étiquettes. Ils ne font pas partie du jouet.

NOTE: Please keep user's manual as it contains important information.

Please adhere the labels to the playset securely as indicated below:

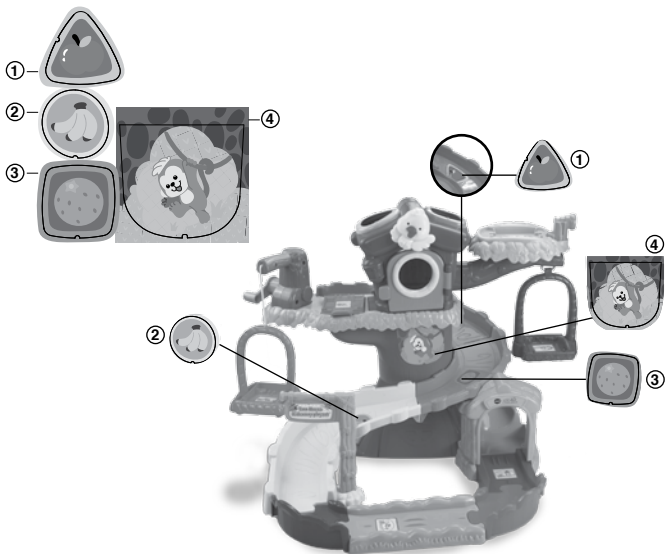

GETTING STARTED

BATTERY INSTALLATION - PANDA

1. Make sure the unit is turned **OFF**.
2. Locate the battery cover on the bottom of the panda. Use a coin or a screwdriver to loosen the screw.
3. Install 2 new 'AAA' (AM-4/LR03) batteries following the diagram inside the battery box. (The use of new alkaline batteries is recommended for maximum performance.)
4. Replace the battery cover and tighten the screw to secure the battery cover.

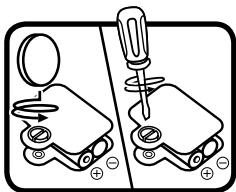

BATTERY NOTICE

- Use new alkaline batteries for maximum performance.
- Use only batteries of the same or equivalent type as recommended.
- Do not mix different types of batteries: alkaline, standard (carbon-zinc) or rechargeable (Ni-Cd, Ni-MH), or new and used batteries.
- Do not use damaged batteries.
- Insert batteries with the correct polarity.
- Do not short-circuit the battery terminals.
- Remove exhausted batteries from the toy.
- Remove batteries during long periods of non-use.
- Do not dispose of batteries in fire.
- Do not charge non-rechargeable batteries.
- Remove rechargeable batteries from the toy before charging (if removable).
- Rechargeable batteries are only to be charged under adult supervision.

ASSEMBLY INSTRUCTIONS

With the VTech® Go! Go! Smart Animals™ Tree House Hideaway Playset™, safety comes first. To ensure your child's safety, adult assembly is required.

1. Attach the tree trunk with track to the tree base as shown. You will hear a “click” sound to indicate the track is secure.
2. Attach the treetop platform to the tree trunk with track. You will hear a “click” sound to indicate the track is secure.
3. Attach the **SmartPoint™** launcher to the treetop platform as shown. You will hear a “click” sound to indicate the track is secure.
4. Attach the elevator basket bracket to the **SmartPoint™** elevator. You will hear a “click” sound to indicate the elevator basket is secure. Once the bracket is connected to the elevator basket, it cannot be detached.



5. Place the elevator basket with hand crank on the treetop platform as shown, and fasten it with the four screws provided.



6. Attach the tree house shape sorter to the treetop platform. You will hear a “click” sound to indicate the treetop platform is secure. Once the tree house shape sorter is connected to the treetop platform, it cannot be detached.

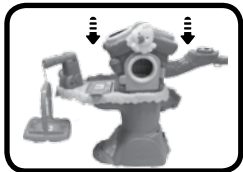

7. Attach the swing bracket to the **SmartPoint™** swing. You will hear a “click” sound to indicate the track is secure. Once the bracket is connected to the **SmartPoint™** swing, it cannot be detached.



8. Attach the swing bracket to the tree house shape sorter as shown. You will hear a “click” sound to indicate the swing is secure.

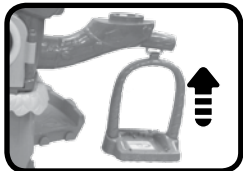

9. Attach the **SmartPoint™** turning telescope platform to the tree house shape sorter. You will hear a “click” sound to indicate the telescope platform is secure.



10. Connect the shape sorter container to the tree base.

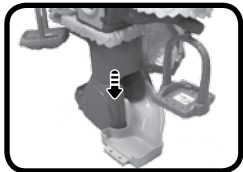

11. Connect the **SmartPoint™** entrance track to the container as shown.

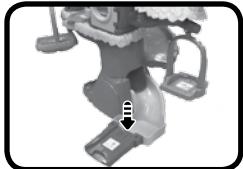

12. Insert the entrance piece to the **SmartPoint™** entrance track.



13. Attach the upper most spiral track piece to the tree trunk with track and entrance piece as shown.

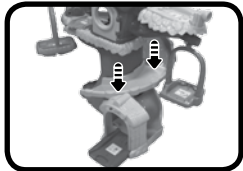

14. Connect the two spiral ramp pieces as shown.



15. Insert the welcome sign into the bottom most spiral ramp piece as shown.

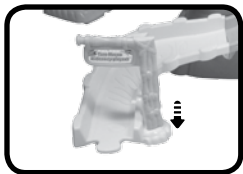

16. Once you've completed the above steps, you are ready to play! You can connect these pieces to the other included track pieces or you can connect this playset to other **Go! Go! Smart Animals™** and **Go! Go! Smart Wheels®** playsets (each sold separately).



PRODUCT FEATURES – PANDA

1. ON/OFF SWITCH

To turn the unit **ON**, slide the **ON/OFF SWITCH** to the **ON** (⏻) position. To turn the unit **OFF** (●), slide the **ON/OFF SWITCH** to the **OFF** (●) position.

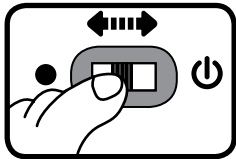

2. AUTOMATIC SHUT-OFF

To preserve battery life, the **VTech® Go! Go! Smart Animals™** panda will automatically power-down after approximately 60 seconds without input. The unit only can be turned on again by pressing the light-up button or pushing the panda quickly.

ACTIVITIES – PANDA

1. Slide the **ON/OFF SWITCH** to the **ON** position to turn the unit on. You will hear a panda sound, a song and a phrase. The light will flash with the sounds.
2. Press the **LIGHT-UP BUTTON** to hear fun sounds, sing-along songs and phrases. The light will flash with the sounds.
3. Push the panda to hear fun sounds and melodies. While a melody is playing, push the panda again to add in fun sounds on top of the melody. The light will flash with the sounds.
4. For added fun, the panda interacts with **VTech® Go! Go! Smart Animals™** playsets (each sold separately). Simply roll the panda over one of the playset's **SmartPoint™** locations to see the light flash and to hear greetings, fun sounds, short tunes and sing-along songs. You can also play with your animal on **Go! Go! Smart Wheels®** playsets (each sold separately).

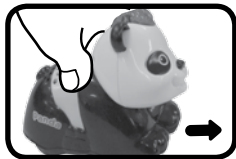
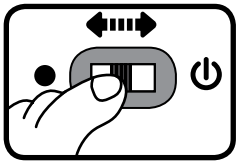

ACTIVITES – TREE HOUSE

1. Move the panda or any **SmartPoint™** animal (each sold separately) over the tree house's six **SmartPoint™** locations to trigger fun sounds, songs, or phrases.
2. Lift the panda to the top of the tree on the elevator basket by turning the elevator crank.
3. To launch the panda down the spiral track, place the panda on the **LAUNCHER** at the top of the treetop platform. Lift up the **LAUNCHER** to see the panda slide down.
4. Rotate the **SmartPoint™** telescope platform to enjoy great views.
5. Insert the shape sorter pieces into the tree house shape sorter's correct locations.

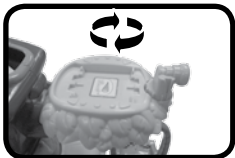

CARE & MAINTENANCE

1. Keep the unit clean by wiping it with a slightly damp cloth.
2. Keep the unit out of direct sunlight and away from any direct heat.
3. Remove the batteries when the unit will not be in use for an extended period of time.
4. Do not drop the unit on hard surfaces and do not expose the unit to moisture or water.

TROUBLESHOOTING

If for some reason the program/activity stops working or malfunctions, please follow these steps:

1. Please turn the unit **OFF**.
2. Interrupt the power supply by removing the batteries.
3. Let the unit stand for a few minutes, then replace the batteries.
4. Turn the unit **ON**. The unit should now be ready to play again.
5. If the product still does not work, replace with a new set of batteries.

If the problem persists, please call our Consumer Services Department at 1-800-521-2010 in the U.S. or 1-877-352-8697 in Canada, and a service representative will be happy to help you.

For information on this product's warranty, please call VTech® at 1-800-521-2010 in the U.S. or 1-877-352-8697 in Canada.

IMPORTANT NOTE:

Creating and developing Infant Learning products is accompanied by a responsibility that we at VTech® take very seriously. We make every effort to ensure the accuracy of the information, which forms the value of our products. However, errors sometimes can occur. It is important for you to know that we stand behind our products and encourage you to call our Consumer Services Department on at 1-800-521-2010 in the U.S. or 1-877-352-8697 in Canada, with any problems and/or suggestions that you might have. A service representative will be happy to help you.

Note:

This equipment has been tested and found to comply with the limits for a Class B digital device, pursuant to Part 15 of the FCC Rules. These limits are designed to provide reasonable protection against harmful interference in a residential installation. This equipment generates, uses and can radiate radio frequency energy and, if not installed and used in accordance with the instructions, may cause harmful interference to radio communications. However, there is no guarantee that interference will not occur in a particular installation. If this equipment does cause harmful interference to radio or television reception, which can be determined by turning the equipment off and on, the user is encouraged to try to correct the interference by one or more of the following measures:

- Reorient or relocate the receiving antenna.
- Increase the separation between the equipment and receiver.
- Connect the equipment into an outlet on a circuit different from that to which the receiver is connected.
- Consult the dealer or an experienced radio/TV technician for help.

THIS DEVICE COMPLIES WITH PART 15 OF THE FCC RULES. OPERATION IS SUBJECT TO THE FOLLOWING TWO CONDITIONS: (1) THIS DEVICE MAY NOT CAUSE HARMFUL INTERFERENCE, AND (2) THIS DEVICE MUST ACCEPT ANY INTERFERENCE RECEIVED, INCLUDING INTERFERENCE THAT MAY CAUSE UNDESIRE OPERATION.

CAN ICES-3 (B)/NMB-3(B)

Caution: Changes or modifications not expressly approved by the party responsible for compliance could void the user's authority to operate the equipment.

CLASS 1
LED PRODUCT